PV4-S/S1 Connector

CONTENT

1	Introduction	2
2	Supporting Document	2
2.1	Drawings.....	2
2.2	Product Specification	2
3	Requirements	2
3.1	General Instructions	3
3.2	Termination of the cable wires / crimping of the contacts	3
3.2.1	<i>Handling Of Connectors and Cables</i>	3
3.2.2	<i>Assembly and Connection of Wire Leads</i>	4
3.2.3	<i>Crimping Tooling</i>	6
3.3	Assembly of Connectors	6
3.3.1	<i>Selection of Sealing & Pinch Ring for Connectors</i>	6
3.3.2	<i>Assembly of the connectors</i>	7
3.4	Connectors Mating.....	8
3.5	Disconnecting	9
4	Applications Examples.....	11
5	Storage.....	12
6	Tools	12

1 Introduction

This specification covers the requirements for application of the PV4-S Connector as well as guideline for the assembly.

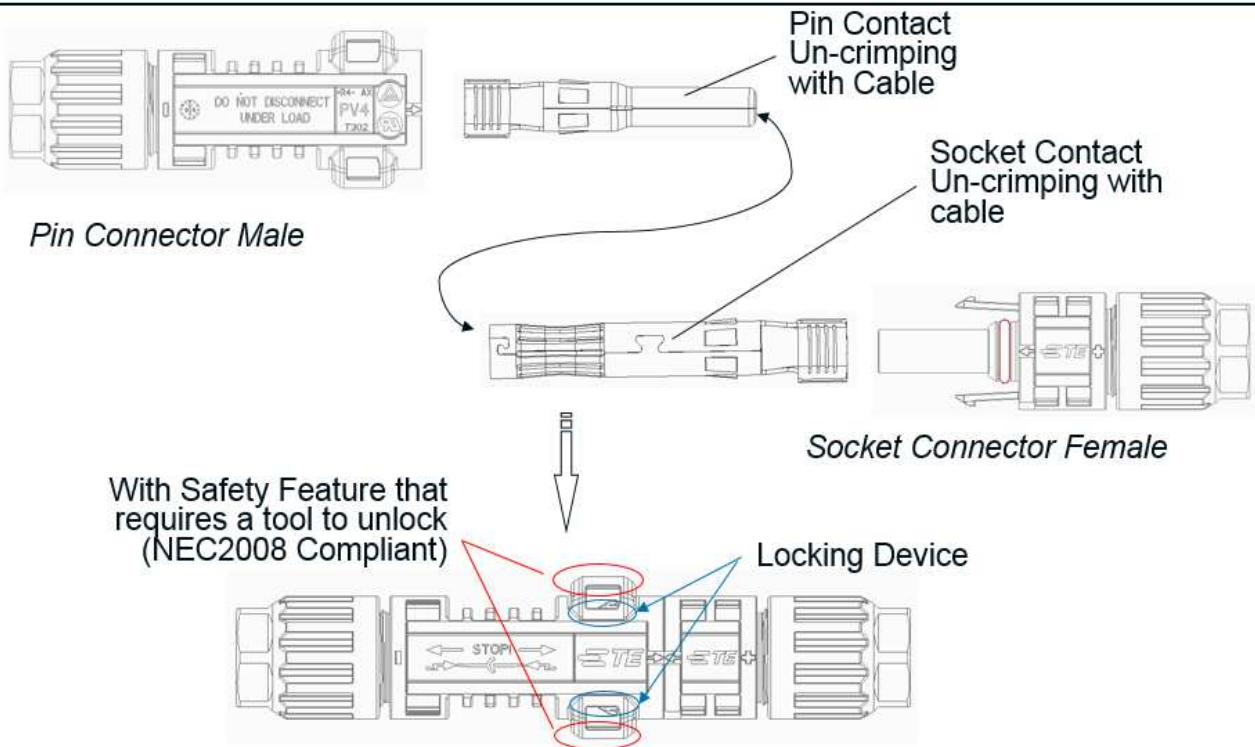

Figure 1

When corresponding with TE connectivity personal, use the terminology in this specification to facilitate your inquiries for information. Basic terms and features of this product are provided in **Figure 1**.

2 Supporting Document

2.1 Drawings

Customer Drawings for product part numbers are available from the service network. If there is a conflict between the information contained in the Customer Drawings and this specification or any other technical documentation supplied, Contact TE Connectivity Engineering.

PV4-SMx/S1Mx (PN 2270024) Pin Connector (Male)
PV4-SFx/S1Fx (PN 2270025) Socket Connector (Female)

Note:

Rating Voltage PV4-SMx/SFx: 1000V TUV/ 1000V UL
PV4-S1Mx/S1Fx: 1500V TUV/ 1500V UL

2.2 Product Specification

Performance specification for the PV4-S 1000V and PV4-S1 1500V Connector can be found in TE Connectivity product specification: 108-137077

3 Requirements



Do NOT disconnect under load!

Current path should only be disconnected using approved disconnect devices.

Symbol "Do not disconnect under load" is marked on the connectors



Mounting and installation must be done by qualified and trained staff considering all applying safety regulations. Failure to follow all instructions in Application Specification (available at www.te.com/documents), including using only approved TE tooling (if applicable), can result in improper installation and/or crimping which is dangerous and may cause or contribute to electrical fires.



Chemical Exposure:

Do NOT allow the connectors contact any chemicals including below but not limited as they may cause stress cracking.

Greases Oils Lubricants Plasticizers Mold release agents

Cleaning agents Organic solvents including aliphatic hydrocarbons, aromatic hydrocarbons, halide hydrocarbons, ketones, alcohols, ethyl acetate, tributyl phosphate, kerosene and gasoline

3.1 General Instructions

Any kind of pollution (dust, humidity, foreign particles etc.) during the assembly process can degrade contact and connectors performance. This applies in particular to the seals and the crimping of the contacts. A clean assembly environment is therefore essential.



Unconnected connectors must always be protected from pollution (e.g.dust humidity, foreign particles, etc), prior to installation. Do NOT leave unconnected (unprotected) connectors exposed to the environment..

3.2 Termination of the cable wires / crimping of the contacts

Connectors use different crimp contacts for various wire gauges. It is necessary to use the proper tool for wire gauge size. Possible connectable wire gauges sizes are 2.5 mm²/AWG14; 4.0 mm²/AWG12, 6.0 mm² /AWG10. The tools to be used are selected based upon the wire gauge.



Shelf life: The contacts should remain in the shipping containers until ready for use to prevent from storage contamination that could adversely affect connection.

3.2.1 Handling Of Connectors and Cables



**The cable must not be bent or crushed on the direct exit of the cable screw joint
A minimum bending radius $R \geq 5 \times$ Cable diameter must be maintained.**

The cable must be routed in a way that the tensile stress on the conductor or connections is prevented (see **Figure 2**).

The PV4 connectors is to be used only to interconnect firmly fixed cables

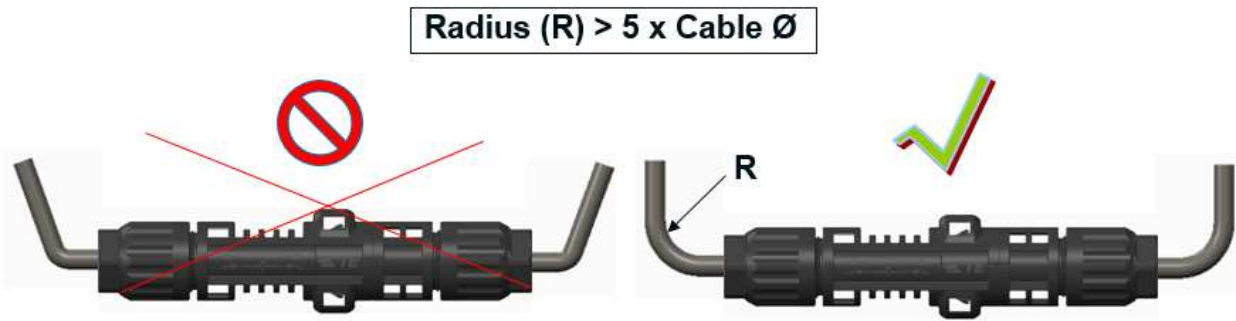

Figure 2

3.2.2 Assembly and Connection of Wire Leads

The crimping contact must be performed in the following procedure:

1) Stripping insulation of the wire lead

Using the appropriate wire stripping tool, strip the wire as indicated in **Figure 3** and **Table 1** without damaging the strands.

Note: Not to Scale

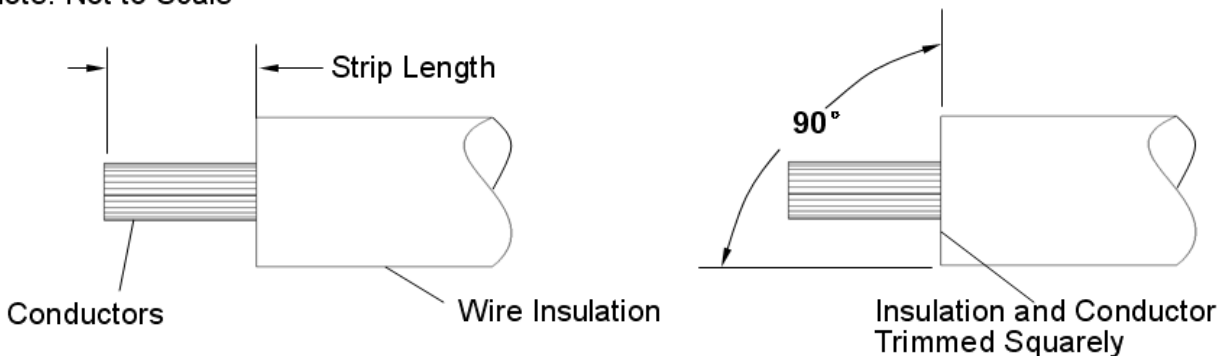

Figure 3

Nominal Wire Size (mm ² / AWG)	Wire Strip Length (mm)
2.5/14 & 4.0/12 & 6.0/10	6.5 ^{+1.0} / _{-0.5}

Table 1

2) Crimping Contacts

Making the crimping contacts connection with suitable cross-section tooling and crimped according to the instructions packaged with the tooling. See section 3.2.3, Crimping Tooling, of this document for detail on tooling options.



The applied crimping dimension (within the functional range of the product) is depended on the crimping tooling being used. Refer to the documentation supplied with the crimping tooling for the applied crimping height.

A. Wire barrel Crimp

The crimp applied to the wire barrel of the contacts is the most of compressed area and is

most critical in ensuring optimum electrical and mechanical performance of the crimped contacts. **The wire barrel crimp height** must be within the dimension in **Table 2**.

Nominal Wire Size (mm ² / AWG)	Wire-End Protrusion Length (mm)	Wire Barrel Crimp Width (mm)	Wire Barrel Crimp Height (mm)
2.5 / 14	1.0±1.0	3.01±0.05	1.88±0.05
4.0 / 12	1.0±1.0	3.94±0.05	2.14±0.05
6.0 / 10	1.0±1.0	3.94±0.05	2.49±0.05

Table 2

Note: The crimp width is tooling depend. Checking the crimp width is checking for the proper tool and not a process control

Note: All of Contact Have Same Dimensions

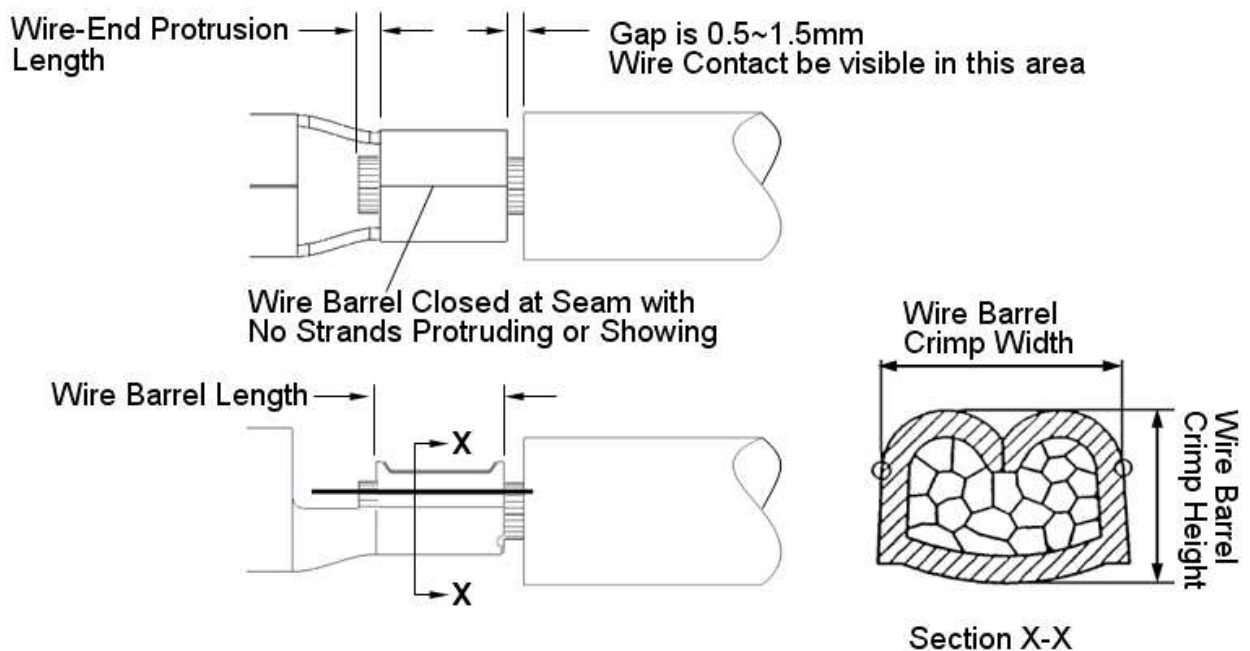

Figure 4

B. Effective Crimp Length

For optimum crimp effectiveness, the crimp must be within the area shown in **Figure 4** and must meet the crimp dimensions provided in **Table 2**.

C. Wire-End Protrusion Length

The wire barrel shall not exceed the dimension shown in **Figure 4** and **Table 2**.

D. Wire Location

The wire conductor must be visible in the transition area between the wire barrel and insulation as shown in **Figure 4**.

E. Wire Barrel Seam

The wire barrel seam must be closed with no evidence of loose wire strands visible in the seam. See **Figure 4**.

3.2.3 Crimping Tooling

Because of the large amount of product variations and application tooling available, it is not feasible to list all the tooling on this document. The operation instructions packaged with that tooling. The following tools are available for the contact crimping

3.2.3.1 Hand Crimping Tool

Hand crimping tools are designed for low-volume application and repair.





No.	TE connectivity Part Number	Wire size	Approval	Order Text	Picture
1	4-1579002-2	2.5 +4.0+6.0mm ²	N/A	SOLARLOK insulation stripper	
2	7-1579016-5	2.5+4.0mm ²	N/A	Hand-crimp tool (complete) for crimping contact	
3	6-1579014-8	4.0+6.0mm ²	N/A	Hand-crimp tool (complete) for crimping contact	
4	4-1579016-7	4.0+6.0mm ²	N/A	Crimp head for crimping contact	

Table 3

3.2.3.2 Applicators

Applicators are designed for the full wire size range of terminals, and provide for high volume or mass production requirements. The applicators can be used in bench or floor model power units.



Each applicator is shipped with a metal identification tag attached. Do not remove this tag or disregard the information on it. Also, a packet of associated paperwork is included in each applicator shipment. This information should be read before using the applicator; then it should be store in a clean, dry area near the applicators for future reference. Some changes may have to be made to the applicators to run in all related power units. Contact TE connectivity corporate engineering.

3.3 Assembly of Connectors

3.3.1 Selection of Sealing & Pinch Ring for Connectors

The connector should select a suitable sealing & pinch ring for assembly according to the outside diameter of the cable.



Pinch Ring selection criterion: Suppose the general tolerance is $\pm 0.2\text{mm}$ max. of cable Outside Diameter (OD), if nominal OD of cable is less than or equal 6.0mm,

1740379-2 is preferred, if nominal OD of cable is bigger than 6.0mm, 1987981-2 is preferred.



Cable Outside Diameter	Pinch Ring Type	Picture
From 6.0 up to 7.8mm	1987981-2	
From 5.5 up to 6.0mm	1740379-2	

Table 4

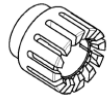

Use only PV1-F wire according to PfG 2 1169 / 08.07 or 2 PfG 1990 / 5.12 (TUV)
The used wire size (mm²/AWG) and the cable outer diameter must be according to the information provided in the Tabel 2 and Table 4.

3.3.2 Assembly of the connectors

The assembly of the connectors must be performed in the following sequence:



Point 1-2 do not apply for prefabricated connector in this case the contact crimped wire lead of cable has to be inserted directly into the correct preassembled connector housing

- 1) The engagement of the Sealing & Pinch Ring into the connector housing until it stop (see Figure 5 and 6)



Figure 5
Connector Housing Components



Figure 6
Preassembled Sealing & Pinch ring

- 2) Connect the cable screw joint nut on to the connector housing (only 2-3 turns).



Figure 7
Preassembled Connector Housing

3) **Insert the contact crimped wire lead of cable until an audible click sound is heard and then give a slight pull back (a maximum of 5~10N force) to check whether the contact is locked.**

a) The contact engagement force is max.25N



Figure 8
assembly: Insertion of contact with crimped wire lead of cable



The Pin Contact shown, the Socket Contact have same the assembly process

4) **Use a slotted torque wrench head (PN 2232097-1) to tighten the cable screw joint nut (see Figure 9)**



Figure 9
Tightening of the cable screw joint nut

(Torque force: 2.0+/-0.1N.m for cable OD 5.5mm~7.0mm, 2.4+/-0.1N.m for cable OD >=7.0mm. The torque force value is for our TE internal Typical cable assembly. To make sure the perfect performance, Please consult TE before connector assembly with your own cable, for different cable have different rigidity.)



In case of replacement components or of assembling / disassembling of the cable entry gland, new pinch rings and seals have to be used. If a visible deformation appears at the clamping area of the cable, the cable end needs to be trimmed to remove the deformed area, also use new housing preassembly.

3.4 Connectors Mating

When mating the connectors, ensure the following;

- ◆ It is only allowed to connect a plus (+) coded connector to a minus (-) coded connector. Connectors with identical polarity mark are **not** allowed to couple (forbidden to use + on + or - on -)

- ♦ Mating of the connectors is done by pushing the connectors together until a clear audible click is heard. This clear audible clicking sound must be heard to ensure the connectors have been mated correctly. When the connectors are correctly connected the latches should be flush against the edge of the connector (see **Figure 10**).

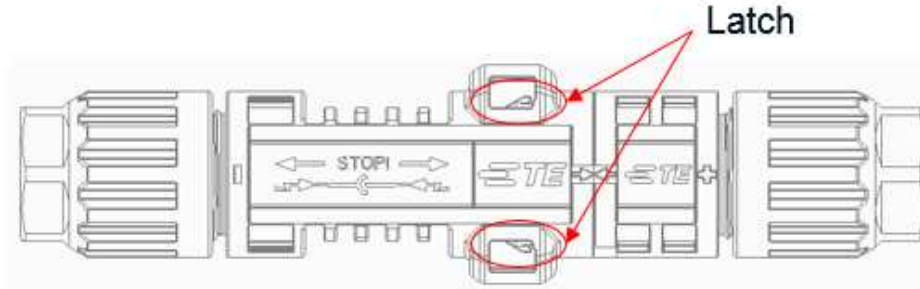

Figure 10

The polarity symbol + or – are marked on the Connector (See Figure 11)

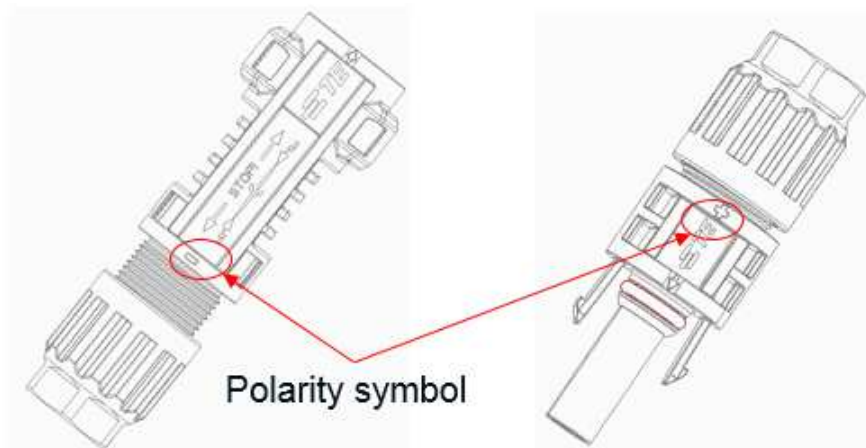

Figure 11

3.5 Disconnecting



Do NOT disconnect under load!

Current path should only be disconnected using approved disconnect devices.

The following hand application tool (**PN 1971903-1**) is available for assembling and disconnecting the connector in **Figure 12**, and tightening the cable screw joint nut for low-volume application and repair.

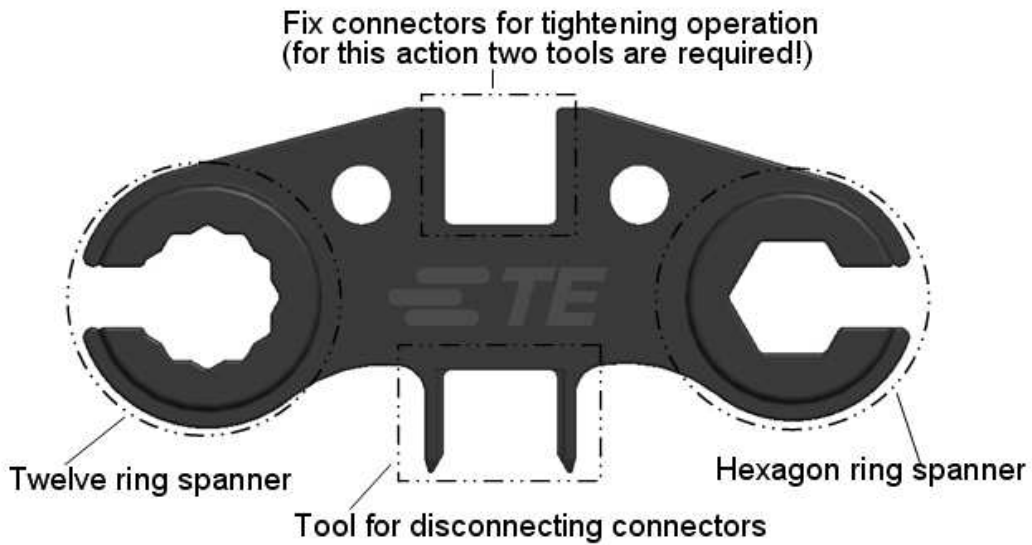

Figure 12
Hand Application Tool

1. The locking mechanism is opened by depressing the latches with hand application tool (**PN 1971903-1**) as shown in **Figure 13**.
2. Disconnect the connectors connection while the special tool insertion into the locking mechanism to depress the latches, and pull the connectors apart.

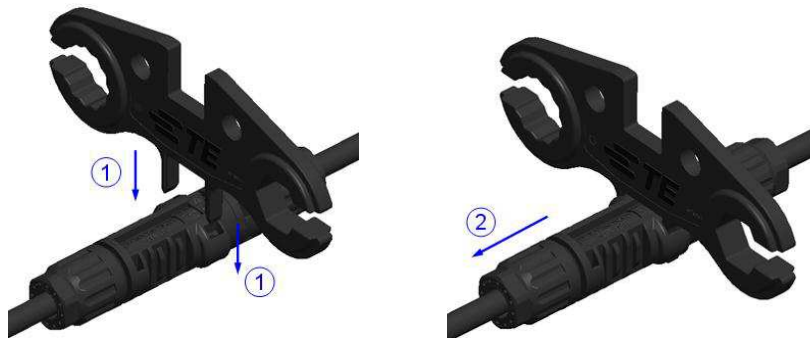

Figure 13
Disconnect the connectors

3. For installation application, it can use opening tooling to tighten operation in **Figure 14**

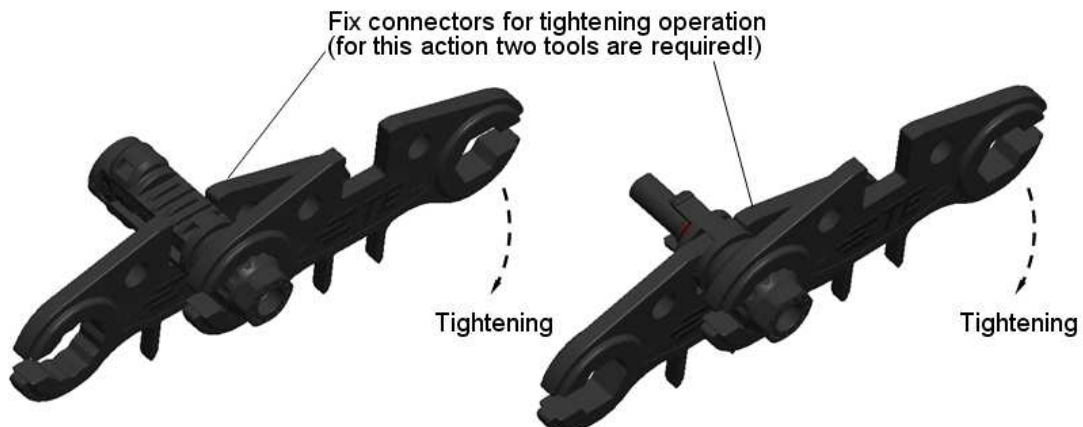

Figure 14
Tightening the connectors with Opening tool



The above disconnecting picture is just show you how to disconnect the connector. Please don't focus on the connector shape that is not exactly same to PV4-S

3.6 Protective Cover for connectors

These protective dust caps serve for the protection against environmental contaminants.



Figure 15

4 Applications Examples

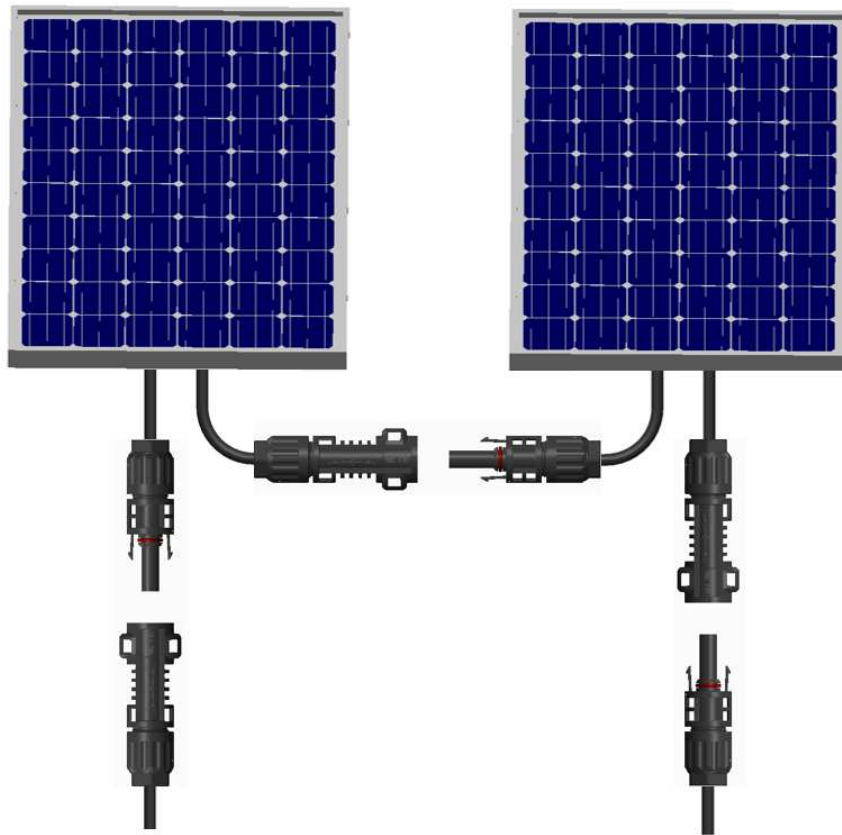

PV-H module Serial connection example

Figure 16

5 Storage

See Product specification 108-137077.

6 Tools

1. The following tools are available for crimping the contacts including hand crimping tool (PN 6-1579014-8) and crimp head (PN 4-1579016-7)
2. Insulation stripper (PN 4-1579002-2) is recommended for stripping the wire.
3. Hand application tool (PN 1971903-1) is available for assembling and disconnecting the connectors.
4. A slotted torque wrench head (PN 2232097-1) is recommended for tightening the cable screw joint nut

NOTE Assembly Part No. selection criterion



Cable Outside Diameter	Assembly Part Number		Packaging
	For Male Connector	For Female Connector	
From 6.0 up to 7.8mm	2270024-1	2270025-1	1000
	2-2270024-1	2-2270025-1	100
From 5.5 up to 6.0mm	2270024-2	2270025-2	1000
	2-2270024-2	2-2270025-2	100

Table 5

Annex A

Documentation Change Record

LTR	Clause	Page	Change Description	DATE	DWN	APRD
A			New release	2014.11.04	LW	PY
A1	Item 2.1 and 2.2	2	Chang the voltage from 1000V to 1500V	2015.05.04	LW	DT
A2		12	Added New Information Table No.5	14JAN2016	KR	ZY
A3	2.1	2	Update rate voltage and model code	1JUN2016	LW	ZY
A3	2.2	2	Update rate voltage and model code	1JUN2016	LW	ZY
A4	3	3	Added chemical exposure	14Nov2016	ZY	SM